

Lethe: A Tunable Delete-Aware LSM-Based Storage Engine

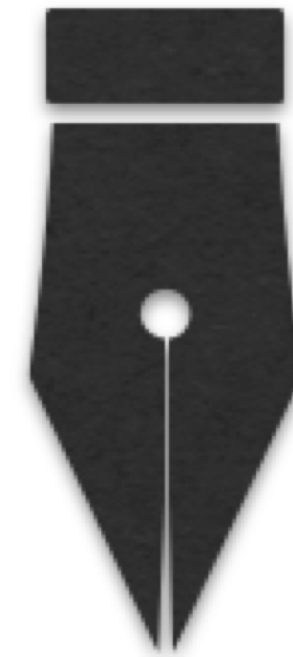

Subhadeep Sarkar
Dimitris Staratzis
Tarikul Islam Papon
Manos Athanassoulis

log-structured merge-tree

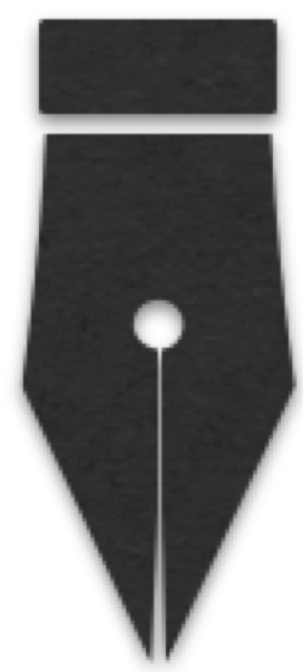

log-structured merge-tree

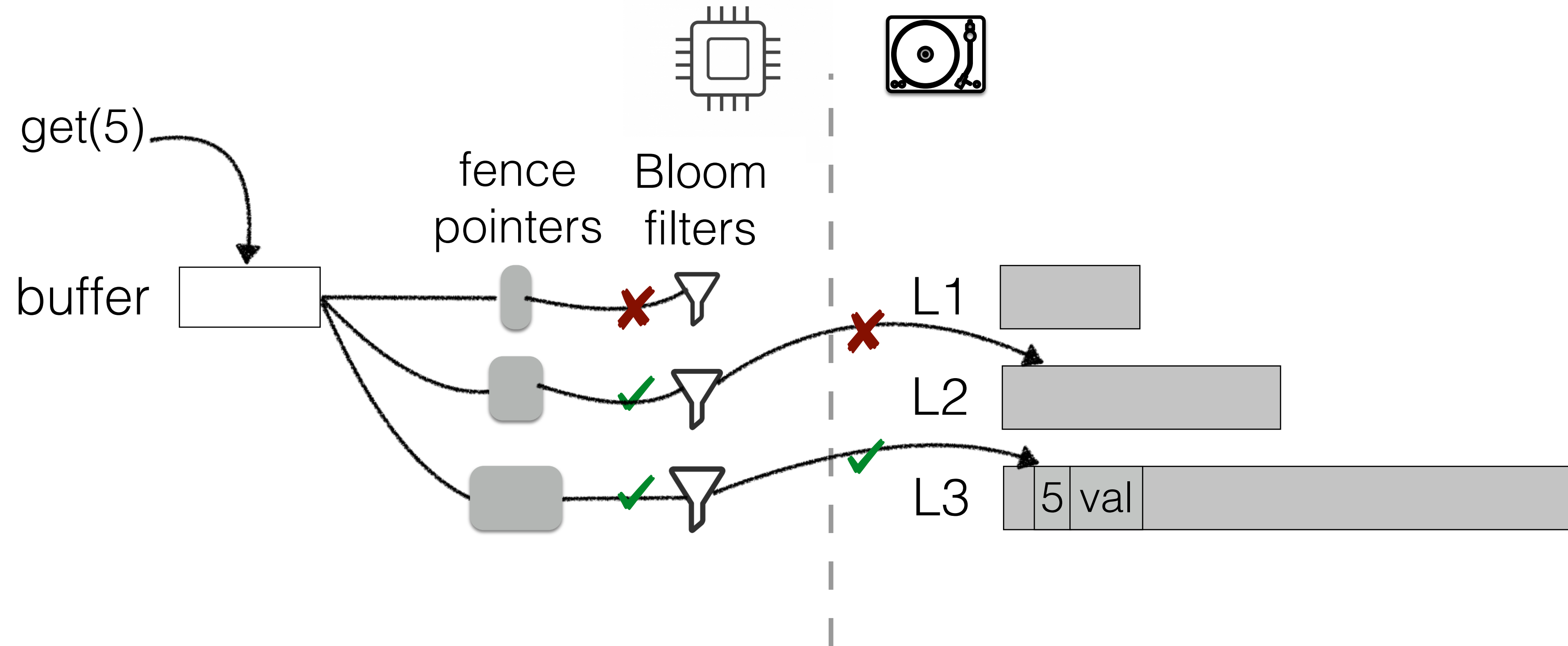

What about deletes?

scenario 1

poor read perf.

space amplification

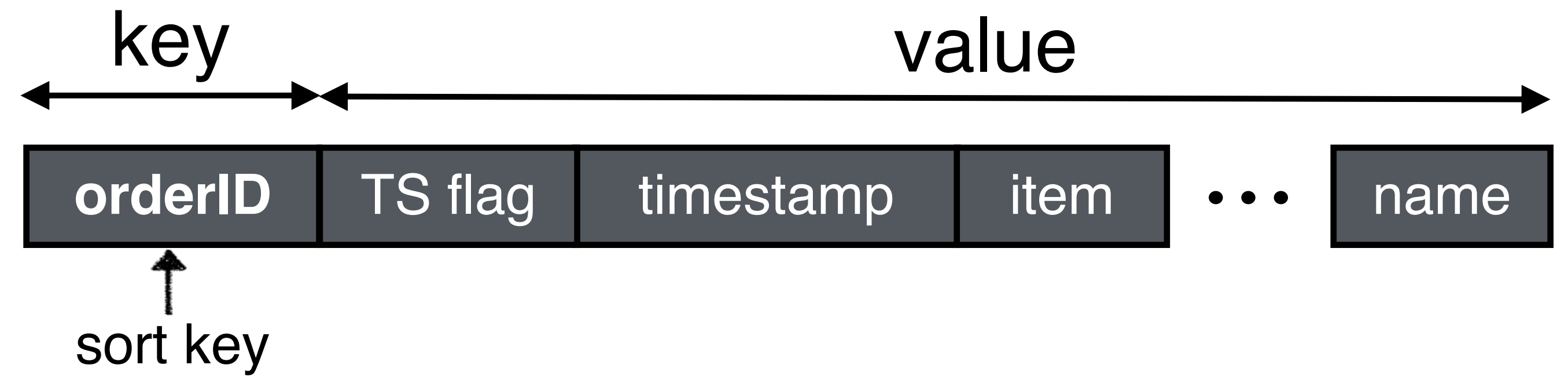

L1

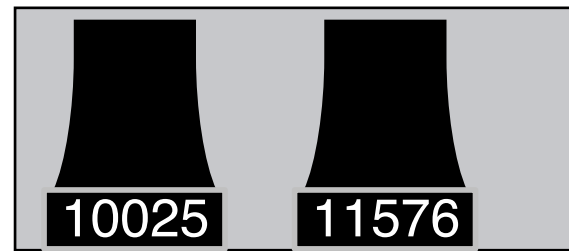

L2



L3



L4



user X: delete my order history



delete(10025)
delete(11567)

scenario 1

poor read perf.

space amplification

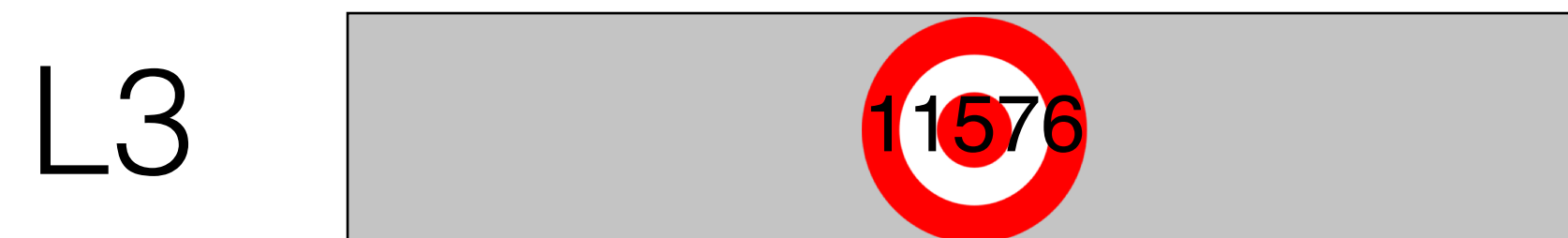
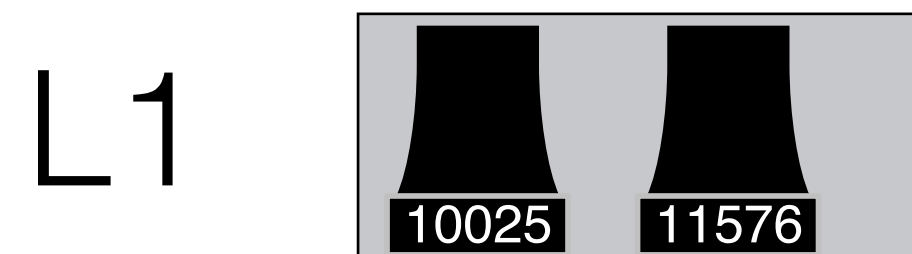
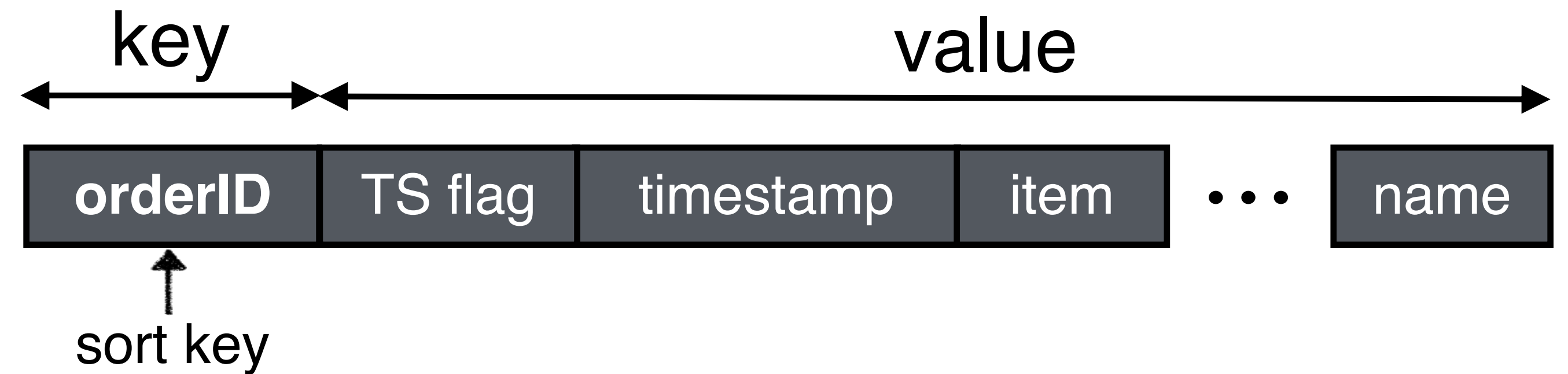

user X: delete my order history within 5 days

data privacy



scenario 2

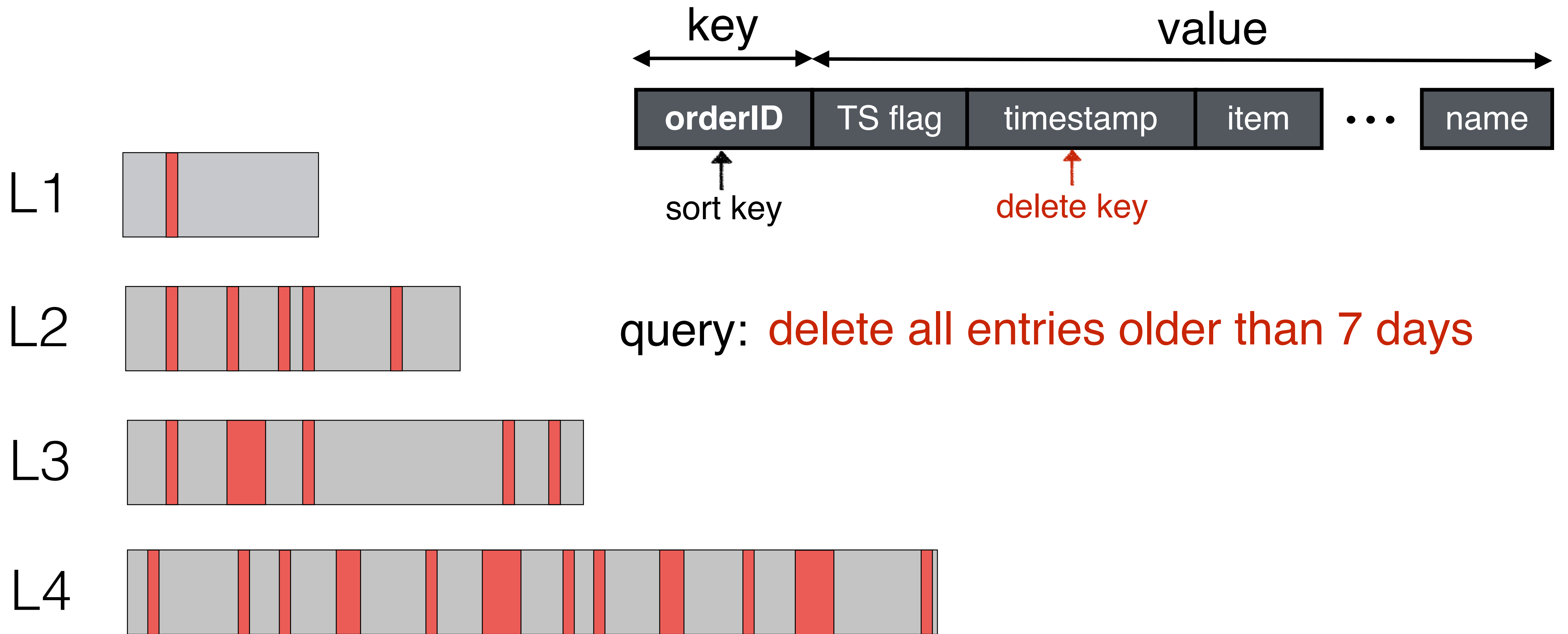

scenario 2

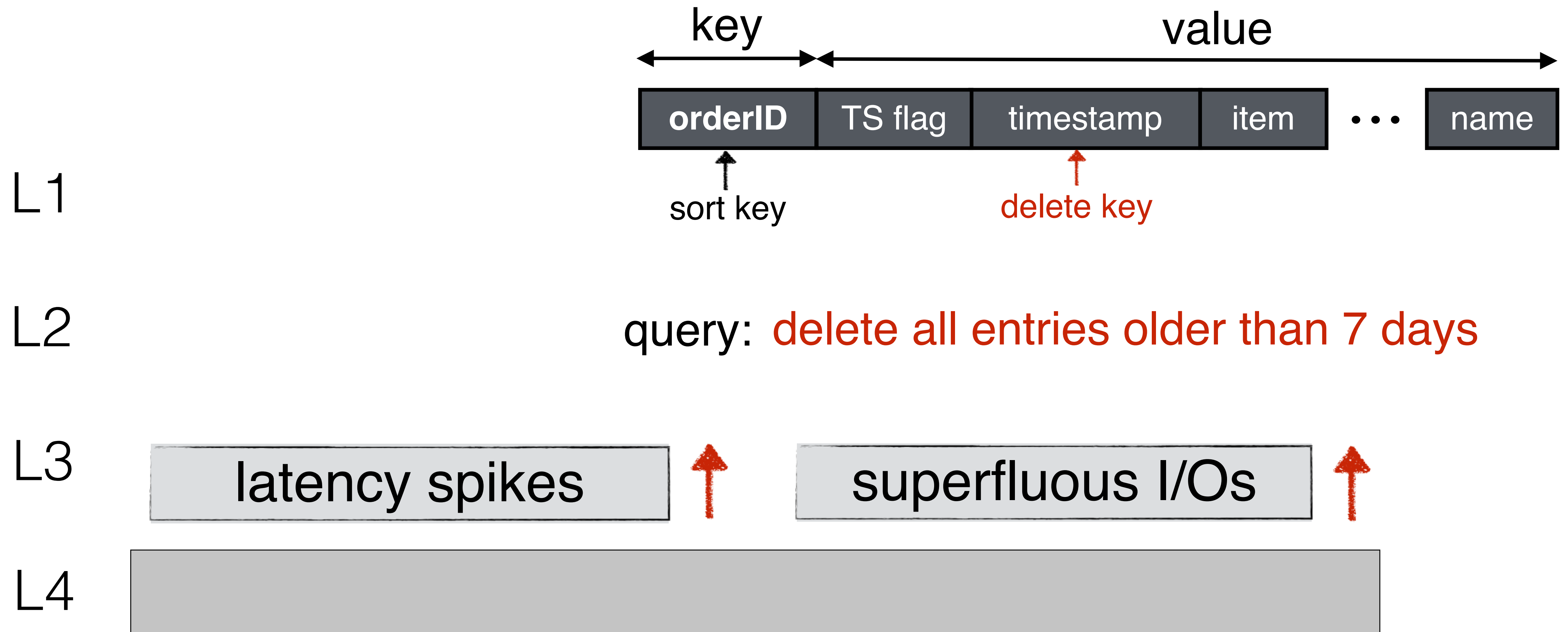

Lethe

FADE

Kiwi

Lethé

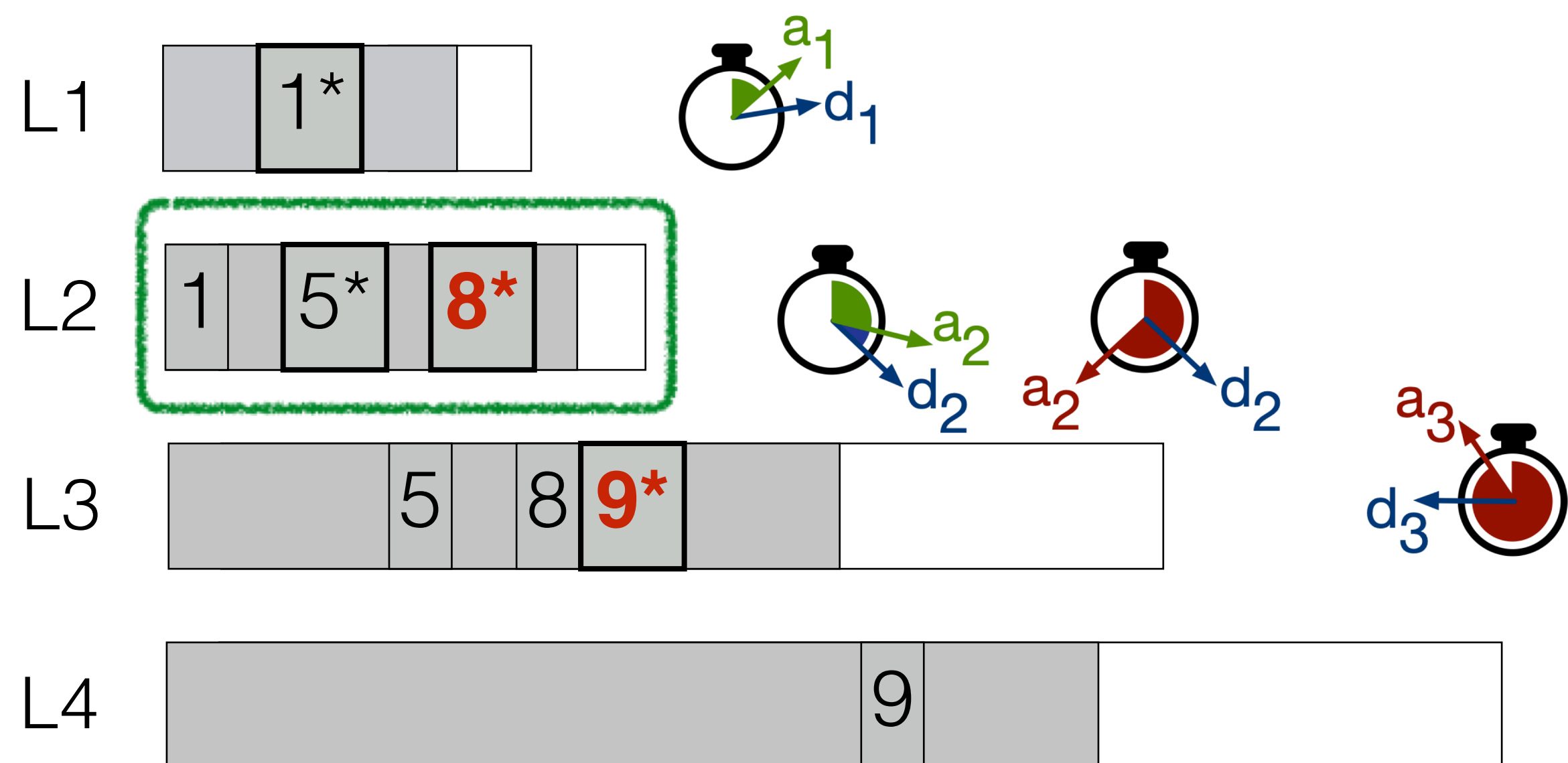

Kiwi

Lethe

FADE

Kiwi

Lethé

FADE

sorted on sort key

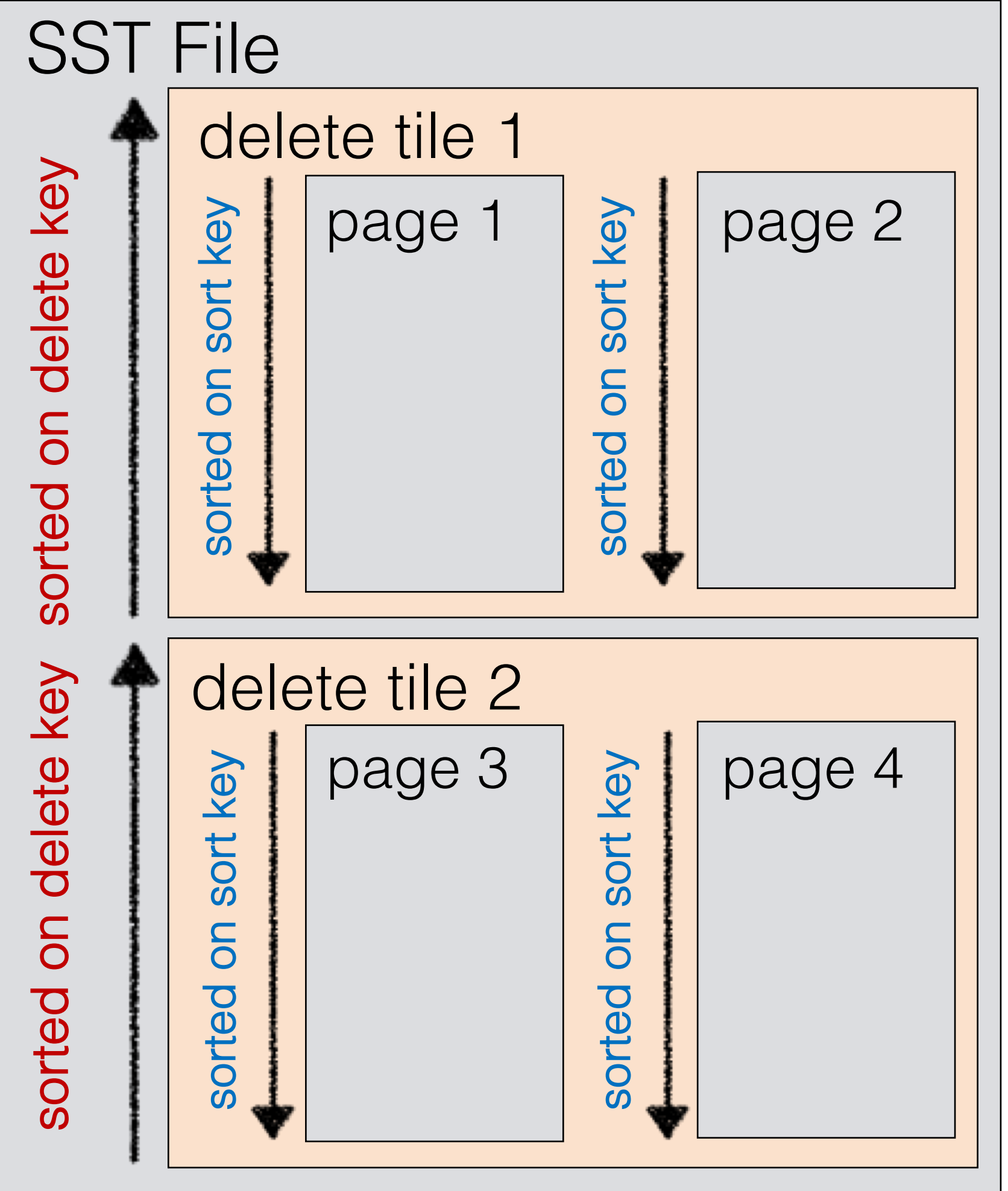

Lethe

FADE

Kiwi

Lethe

FADE

Kiwi

Visit us in the Poster Session!